

## **INSTRUCTION MANUAL**

# **MPR-414F MPR-414FS**

**Pharmaceutical Refrigerator  
with Freezer**



**MPR-414F**

## Note:

1. No part of this manual may be reproduced in any form without the expressed written permission of SANYO.
2. The contents of this manual are subject to change without notice.
3. Please contact SANYO if any point in this manual is unclear or if there are any inaccuracies.

SANYO Electric Biomedical Co., Ltd. All rights reserved. Printed in Japan.

## CONTENTS

PRECAUTIONS FOR SAFE OPERATION	P. 2
CAUTIONS FOR USAGE	P. 6
ENVIRONMENTAL CONDITIONS	P. 7
REFRIGERATOR COMPONENTS	P. 8
INSTALLATION	P. 11
START-UP OF UNIT	P. 12
OPERATING INSTRUCTIONS	P. 13
ALARMS AND SAFETY FUNCTIONS	P. 17
SETTING OF ALARM RESUME TIME	P. 18
DEFROSTING	P. 19
MAINTENANCE	P. 20
OPTIONAL COMPONENT	P. 21
TROUBLESHOOTING	P. 24
DISPOSAL OF UNIT	P. 24
SPECIFICATIONS	P. 25
PERFORMANCE	P. 26
SAFETY CHECK SHEET	P. 27

# PRECAUTIONS FOR SAFE OPERATION

**It is imperative that the user complies with this manual as it contains important safety advice.**

Items and procedures are described so that you can use this unit correctly and safely. If the precautions advised are followed, this will prevent possible injury to the user and any other person.

Precautions are illustrated in the following way:



## **WARNING**

Failure to observe WARNING signs could result in a hazard to personnel possibly resulting in serious injury or death.

## **CAUTION**

Failure to observe CAUTION signs could result in injury to personnel and damage to the unit and associated property.

Symbol shows;

-  this symbol means caution.
-  this symbol means an action is prohibited.
-  this symbol means an instruction must be followed.

Be sure to keep this manual in a place accessible to users of this unit.















< Label on the unit >

This mark is labeled on the cover in which the electrical components of high voltage are enclosed to prevent the electric shock.

The cover should be removed by a qualified engineer or a service personnel only.









# PRECAUTIONS FOR SAFE OPERATION

## **WARNING**

-  **Do not use the unit outdoors.** Current leakage or electric shock may result if the unit is exposed to rain water.
  -  **Only qualified engineers or service personnel should install the unit.** The installation by unqualified personnel may cause electric shock or fire.
  -  **Be sure to install the unit on a sturdy floor.** If the floor is not strong enough or the installation site is not adequate, this may result in injury from the unit falling or tipping over.
  -  **Never install the unit in a humid place or a place where it is likely to be splashed by water.** Deterioration of the insulation may result which could cause current leakage or electric shock.
  -  **Never install the unit in a flammable or volatile location.** This may cause explosion or fire.
  -  **Never install the unit where acid or corrosive gases are present** as current leakage or electric shock may result due to corrosion.
  -  **Make sure a dedicated power source is used** as indicated on the rating label attached to the unit.
  -  **Make sure to remove dust from the power supply plug** before inserting in a power source. A dusty plug or improper insertion may pose a hazard.
  -  **Use a power supply outlet with ground (earth)** to prevent electric shock. If the power supply outlet is not grounded, it will be necessary to install a ground by qualified engineers.
  -  **Never ground the unit through a gas pipe, water main, telephone line or lightning rod.** Such grounding may cause electric shock in the case of an incomplete circuit.
  -  **Do not insert metal objects such as a pin or a wire into any vent, gap or any outlet** for inner air circulation. This may cause electric shock or injury by accidental contact with moving parts.
  -  **Never store volatile or flammable substances** in this unit. This may cause explosion or fire.
  -  **Never store corrosive substances** in this unit. This may lead to damage to the inner components or electric parts.
- If this unit is to be used for storing poisons, radioactive material or other harmful products, ensure that it is in a safe area.** Failure to do so may lead to an adverse effect on the health of personnel in the area and the local environment. In this case, a request for repair or maintenance will necessitate a safety check sheet for maintenance personnel.

















# PRECAUTIONS FOR SAFE OPERATION

## **WARNING**

-  **Always disconnect the power supply to the unit prior to any repair or maintenance** of the unit in order to prevent electric shock or injury.
-  **Ensure you do not inhale or consume medication or aerosols** from around the unit at the time of maintenance. These may be harmful to your health.
-  **Never splash water directly onto the unit** as this may cause electric shock or short circuit.
-  **Never disassemble, repair, or modify the unit yourself.** Any such work carried out by an unauthorized person may result in fire or injury due to a malfunction.
-  **Make the power supply to the unit is disconnected when the lamp is replaced** as this will prevent electric shock.
-  **Disconnect the power supply plug if there is something wrong with the unit.** Continued abnormal operation may cause electric shock or fire.
-  If the unit is to be stored unused in an unsupervised area for an extended period, **ensure that children do not have access and that doors cannot be closed completely.**
-  **The disposal of the unit should be accomplished by appropriate personnel. Always remove doors** to prevent accidents such as suffocation.
-  **Make sure to prepare a safety check sheet** when you request any repair or maintenance for the safety of service personnel.

# PRECAUTIONS FOR SAFE OPERATION

## CAUTION

-  **Select a level and sturdy floor for installation.** This precaution will prevent the unit from tipping. Improper installation may result in water spillage or injury from the unit tipping over.
-  **Connect the unit to a power source as indicated on the rating label attached to the unit.** Use of any other voltage or frequency other than that on the rating label may cause fire or electric shock.
-  **Fix the shelves securely.** Incomplete installation may cause injury or damage.
-  **When removing the plug from the power supply outlet, grip the power supply plug, not the cord.** Pulling the cord may result in electric shock or fire by short circuit.
-  **Never damage or break the power supply plug or cord. Do not use the supply plug if its cord is loose.** This may cause fire or electric shock.
-  **Do not touch any electrical parts** such as the power supply plug or any switches with a wet hand. This may cause electric shock.
-  **Do not climb onto the unit or do not put articles on the unit.** This may cause injury by tipping or damage to the unit.
-  **Do not store bottle or cans in the freezer.** This may cause injury by broken of containers due to the frozen.
-  **Do not touch any stock (especially metal objects) in the freezer with a wet hand.** This may cause frostbite.
-  **Always hold the handle when closing the door.** This will reduce the likelihood of a trapped finger.
-  **Never lean or press on the glass.** Intentional force may cause injury if the glass breaks.
-  **Do not lean on the door.** This may cause injury if the unit tips over.
-  **Always disconnect the power supply plug** before moving the unit. Take care not to damage the power cord. A damaged cord may cause electric shock or fire.
-  **Dispose of water in the evaporation tray completely prior to the movement.** Spilled water or splashed water may cause current leakage or electric shock.
-  **Be careful not to tip over the unit** during movement to prevent damage or injury.
-  **Always disconnect the power plug** when the unit is not used for long periods.
-  **Do not put the packing plastic bag within reach of children** as suffocation may result

# CAUTIONS FOR USAGE

1. If the unit is unplugged or the power to the unit is interrupted, do not restart the unit for at least 5 minutes. This protects the compressor.
2. This inner cabinet is refrigerated by the forced circulation of cooled air inside the chamber. Ensure that the intake and exhaust vents are not blocked. Adequate space should be provided between the items inside the unit to allow air circulation. Too much stock will result in temperature of about  $-2^{\circ}\text{C}$  around the exhaust vent when the set temperature is  $2^{\circ}\text{C}$ . It is recommended to set the temperature to  $4^{\circ}\text{C}$  or  $5^{\circ}\text{C}$  when a large quantity of articles that should not be frozen are stored.
3. Never store corrosive materials such as acid or alkali unless the container is completely sealed up. Corrosion may lead to failure of the unit in time.
4. If the ambient temperature is fairly high, the alarm lamp is flashed, temperature display is flashed, and the buzzer sounds at the time of initial start up. The alarm is canceled automatically when the chamber temperature is decreased.
5. Once the chamber temperature has stabilized, put the items into the chamber in small batches to minimize the temperature increase.
6. Fix the shelves securely. Place items on the shelves and leave a space between the walls of the cabinet and the contents to allow air circulation. Do not place items on the floor of the chamber.
7. Always close the door firmly. The door check lamp is lit when the door is open. The alarm buzzer sounds two minutes after door opening. The buzzer can be canceled automatically when the door is closed.
8. Always open and close the door gently. Rough operation may lead fall down of stocked items, incomplete closing, or damage of door gasket.
9. In the refrigerator compartment, put the items on the shelves and do not contact the items with wall.
10. The cooling pipe is routed in the rear of the freezer. Never use a knife or a screw driver, etc. to remove the frost. They may cause damage of chamber wall or improper operation of the unit. And do not drop any heavy items or sharp edge materials onto the freezer floor.
11. Stop the freezer operation by following the procedure on page 19 "Defrosting" when the freezer is not used or at the time of defrosting of freezer. Under such condition, the freezer is not cooled down at all.
12. If an instrument requiring a power source is to be placed inside the cabinet, the cable can be lead through the access port on the back side of the cabinet. After using of the port, a rubber cap and insulation should be replaced to seal the access port. Failure to do this can affect the temperature uniformity inside the cabinet and lead to condensation on the outside of the access port.

---

# CAUTIONS FOR USAGE

---

**13.** Do not clean the unit with scrubbing brushes, acid, thinner, solvents powdered soap, cleanser or hot water. These agents can scratch the paint or cause it to peel. Plastic and rubber parts can be easily damaged by these materials. Especially never use any volatile solvent to clean the plastic or rubber parts. When a neutral dishwashing detergent is used to clean the unit, wipe it up thoroughly with a cloth soaked in clean water.

**14.** If condensation forms on the front glass or frame surface, wipe it off with a dry soft cloth.

**15.** The heat discharge pipe is attached inside of the rear frame. The rear frame sometimes hot at the start-up of the operation. But this does not mean malfunction.

---

# ENVIRONMENTAL CONDITIONS

---

This equipment is designed to be safe at least under the following conditions (based on the IEC 1010-1):

1. Indoor use;
2. Altitude up to 2000 m;
3. Ambient temperature 5°C to 40°C
4. Maximum relative humidity 80% for temperature up to 31°C decreasing linearly to 50% relative humidity at 40°C;
5. Mains supply voltage fluctuations not to exceed  $\pm 10\%$  of the nominal voltage;
6. Other supply voltage fluctuations as stated by the manufacturer;
7. Transient overvoltages according to Installation Categories (Overvoltage Categories) II; For mains supply the minimum and normal category is II;
8. Pollution degree 2 in accordance with IEC 664.

# REFRIGERATOR COMPONENTS

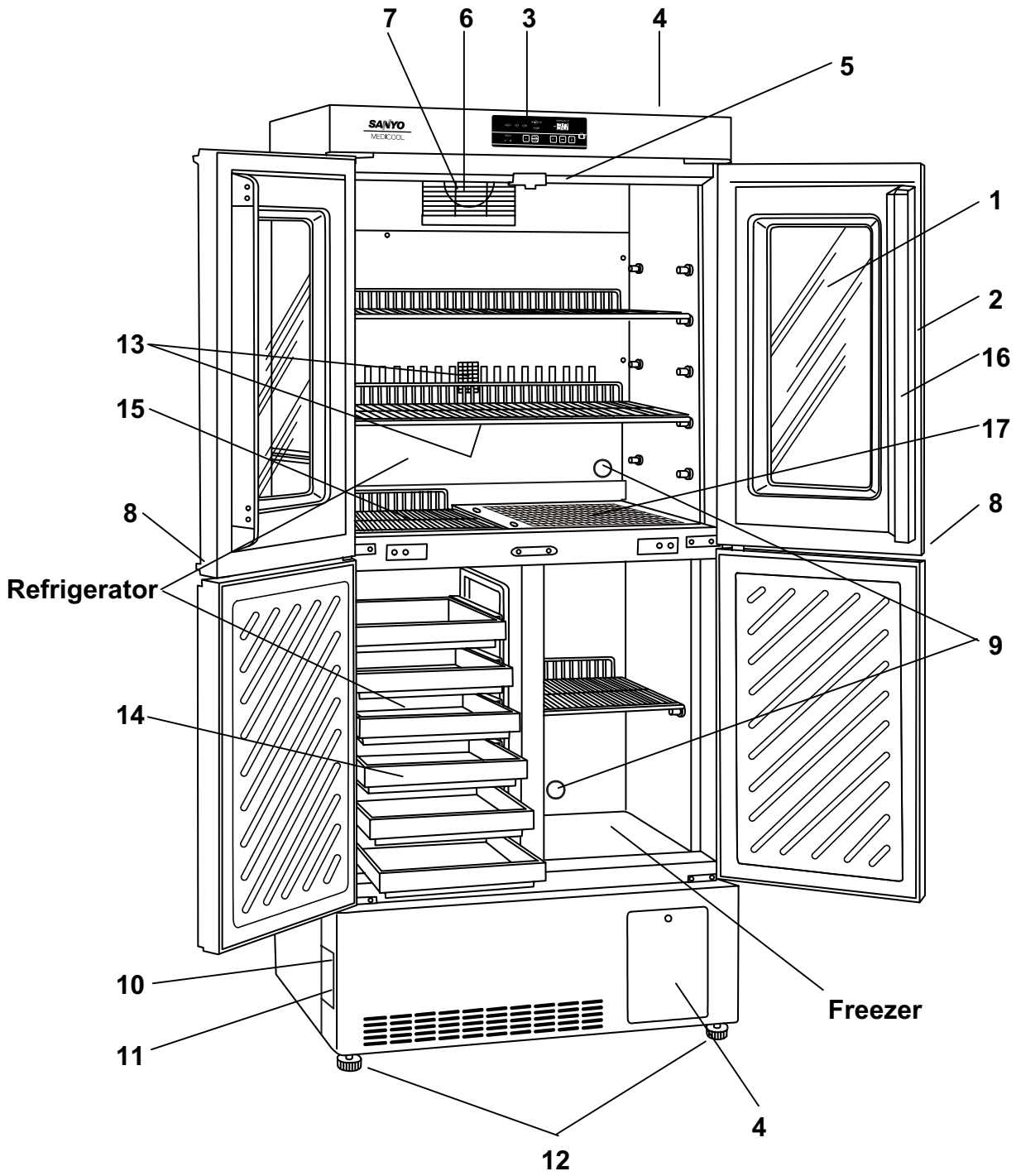

**MPR-414F with drawers (optional component)**

# REFRIGERATOR COMPONENTS

- 1. Glass window:** Water can sometimes condense on the glass in areas of high humidity. Wipe off the condensation with a dry soft cloth. (MPR-414FS has no glass window.)
- 2. Magnetic door gasket:** This prevents the cool air from escaping. Always keep clean.
- 3. Control panel:** The operation status is displayed on this panel. And the temperature setting is available through this panel. Refer to page 10 for the details.
- 4. Mounting space for temperature recorder:** Space for an automatic temperature recorder available separately. See page 21 for the mounting of the recorder.
- 5. Lamp:** This lamp lights up when the refrigerator door is open to illuminate the chamber.
- 6. Air intake vent:** Ensure this vent is never blocked. Failure to do so will result in unstable temperature distribution in the refrigerator.
- 7. Circulating fan:** This is for cooling the refrigerator uniformly. Fan is installed inside the enclosure. Do not insert anything into the enclosure. The air exhaust vent is located at the upper of the fan.
- 8. Lock:** Turn key clockwise through 180 degree to lock the door. The right side lock is for the right upper and lower doors and left side lock is for the left upper and lower doors.
- 9. Access port (rear):** This port allows cables to be passed into the cabinet.
- 10. Power switch (also functions as a circuit breaker):** The power switch also used as a circuit breaker. Normally put a cover on the switch. The round button under the power switch is a leakage test button. The operation check of the circuit breaker can be performed by pressing this button. But note the power supply to the unit is disconnected when this button is pressed.
- 11. Remote alarm terminal:** This is used to alarm the abnormality to the remote location. See page 14 for the details.
- 12. Leveling feet:** Use these bolts to adjust the height and level the unit for installation.
- 13. Cool air exhaust vent:** Ensure this vent is never blocked. Note the items exposed to the direct air flow can be frozen.
- 14. Drawer:** Drawers are available as an optional component (MPR-41R).
- 15. Shelf (at the opening between upper and lower chamber):** Ensure this surface is never blocked by the stored items so that the cool air can be circulated into the lower chamber.
- 16. Movable center pillar:** The pillar contact the door gasket firmly when the door is closed and functions as a block between the chamber and outer air. When the door is opened, the pillar angle is changed by 90 degree. Take care not to change the pillar angle.
- 17. Protective sheet:** The stored material may be frozen if it is put on the chamber bottom directly. Always put the sheet in the refrigerator compartment (upper and lower left chamber).

# REFRIGERATOR COMPONENTS

## Control panel

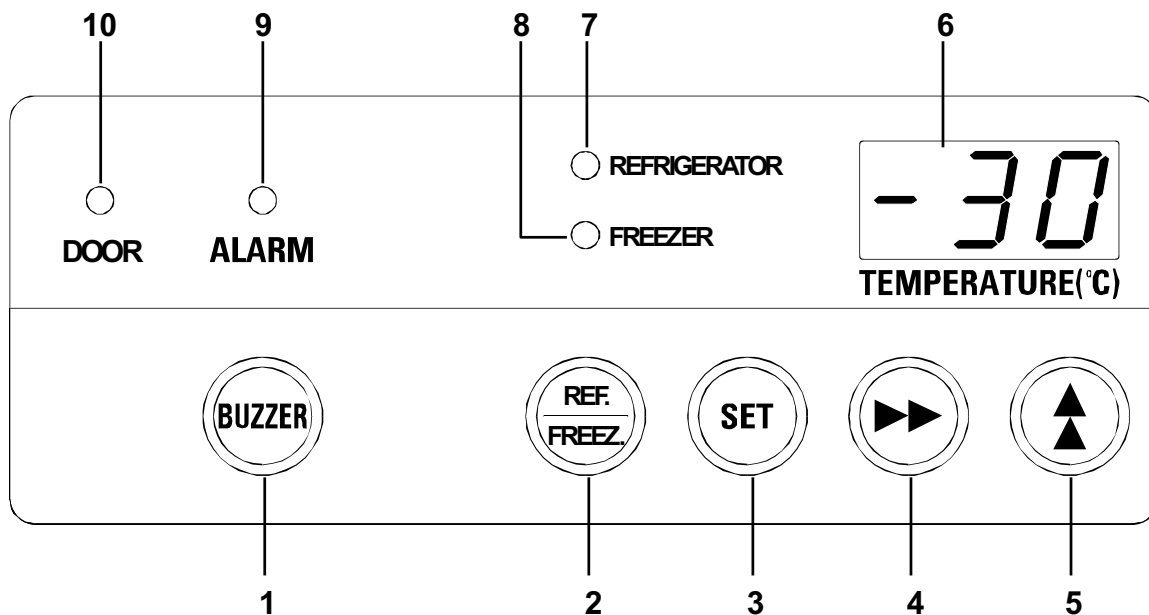

**1. Alarm buzzer stop key (BZ):** Press this key to silence the buzzer in the event that the alarm operates and buzzer sounds. See page 17 for the details.

**2. Display select key (REF./FREEZ.):** By pressing this key, chamber temperature display of refrigerator or freezer and each setting is selected.

**3. Set key (SET):** Pressing this key activates temperature set mode and the digit which can be set is flashed. By pressing the key again after setting, the set value is accepted.

**4. Digit shift key (▶▶):** Pressing this key in set mode causes the changeable digits to move. Key lock is activated by pressing this key for more than 5 seconds in the temperature display mode. See “Key lock operation” on page 14.

**5. Numerical value shift key (▲):** Pressing this key in the setting mode causes the numerical value to change. “ON-OFF” of key lock can be selected by pressing this key in the key lock mode.

**6. Temperature display:** This indicator shows the chamber temperature, set temperature, or error code.

**7. Refrigerator indicator (REFRIGERATOR):** This indicator is lit when the refrigerator is selected.

**8. Freezer indicator (FREEZER):** This indicator is lit when the freezer is selected.

**9. Alarm lamp (ALARM):** This lamp is flashed during alarm condition. Refer to page 15 “Alarm temperature setting”.

**10. Door check lamp (DOOR):** This lamp is lit when the door is open.

# INSTALLATION

## Installation site

To operate this unit properly and to obtain maximum performance, install the unit in a location with the following conditions:

### 1. A location not subjected to direct sunlight

Installation in a location subjected to direct sunlight may lead to inadequate cooling.

### 2. A location with adequate ventilation

Leave at least 10cm around the unit for ventilation. Poor ventilation will result in a reduction of the refrigeration capacity.

### 3. A location away from heat generating sources

Avoid installing the unit near heat-emitting appliances such as gas ranges or stoves. Heat can cause inefficient refrigeration.

### 4. A location with a sturdy and level floor

Install the unit on a sturdy floor to avoid vibration and noise. Placing the unit on an unsteady floor may cause vibration and noise.

#### **WARNING**

**Be sure to install the unit on a sturdy floor.** If the floor is not strong enough or the installation site is not adequate, this may result in injury from the unit falling or tipping over.

#### **CAUTION**

**Select a level and sturdy floor for installation.** This precaution will prevent the unit from tipping. Improper installation may result in water spillage or injury from the unit tipping over.

### 5. A location not prone to high humidity

#### **WARNING**

**Do not use the unit outdoors.** Current leakage or electric shock may result if the unit is exposed to rain water.

**Never install the unit in a humid place or a place where it is likely to be splashed by water.** Deterioration of the insulation may result which could cause current leakage or electric shock.

**Do not install the unit under water pipes or steam pipes.** Deterioration of the insulation may result which could cause current leakage or electric shock.

### 6. A location without a flammable or corrosive gas

Avoid placing the unit where chemicals are stored or gases are produced. Also avoid areas where there is a great deal of dust.

#### **WARNING**

**Never install the unit in a flammable or volatile location.** This may cause explosion or fire.

**Never install the unit where acid or corrosive gases are present** as current leakage or electric shock may result due to corrosion.

# INSTALLATION

## Installation

### 1. Remove the packaging materials and tapes

Remove all transportation packaging materials and tapes. Open the doors and ventilate the unit. If the outside panels are dirty, clean them with a diluted neutral dishwashing detergent. (Undiluted detergent can damage the plastic components. For the dilution, refer to the instruction of the detergent.) After the cleaning with the diluted detergent, always wipe it off with a wet cloth. Then wipe off the panels with a dry cloth.

### 2. Adjust the leveling foot

Extend the leveling feet by rotating them counterclockwise to contact them to the floor. Ensure the unit is level.

### 3. Fix the unit

Two fixtures are attached to the rear of the frame. Fix the frame to the wall with these fixtures and rope or chain.

### 4. Ground (earth)

#### **WARNING**

**Use a power supply outlet with ground (earth) to prevent electric shock.** If the power supply outlet is not grounded, it is necessary to install a ground by qualified engineers.

**Never ground the unit through a gas pipe, water main, telephone line or lightning rod.** Such grounding may cause electric shock in the case of an incomplete circuit.

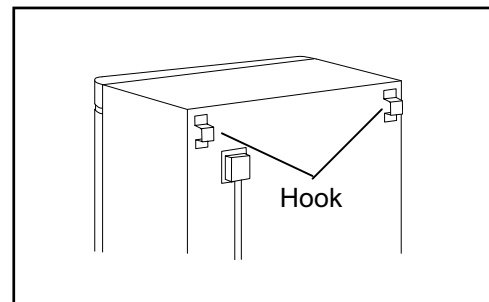
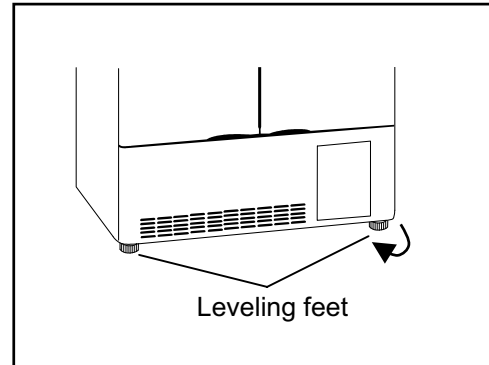

# START-UP OF UNIT

The following procedures should be adhered to for initial start-up and continuous operation.

1. Connect the unit to dedicated power supply and turn on the power switch. Do not put any product in the unit at this time.
2. On start-up, the alarm buzzer sometimes operates. In this case, stop the buzzer by pressing the alarm buzzer stop key (BUZZER).
3. Set the desired temperature.
4. Confirm that the chamber temperature is at the desired temperature.
5. When you are satisfied that the unit is working correctly, begin slowly placing product into the chamber to minimize the temperature rise.

# OPERATING INSTRUCTIONS

## Temperature setting

Table 1 shows the basic operation method. Perform key operation in the sequence indicated in the table. The example in the table is based on the assumption that the refrigerator temperature is 4°C and the freezer temperature is -25°C.

**Note:** The unit is set at the factory so that the refrigerator temperature is 5°C and the freezer temperature is -20°C.

Table 1 Basic operation procedure (Example of setting: refrigerator; 4°C, freezer; -25°C)

	Operation	Key operated	Indication after operation
1	Connect to the power source and turn on the power switch.	----	The current refrigerator or freezer temperature is displayed.
2	Select refrigerator (REF.) by pressing display select key.	REF. FREEZ.	The refrigerator indicator lights and the current refrigerator temperature is displayed.
3	Press SET key.	SET	The current set temperature is displayed and the second digit of the temperature display flashes.
4	Set to 004 by using digit shift key and numerical value shift key.		Pressing the key leads the flash of the first digit.
			Pressing the key shifts up the figure of the current digit.
5	Press SET key.	SET	The value is stored in memory and the current refrigerator temperature is displayed.
6	Select freezer (FREEZ.) by pressing display select key.	REF. FREEZ.	The freezer indicator lights and the current freezer temperature is displayed.
7	Press SET key.	SET	The current set temperature is displayed and the second digit of the temperature display flashes.
8	Set to -25 by using digit shift key and numerical value shift key.		Pressing the key leads the flash of the first digit.
			Pressing the key shifts up the figure of the current digit.
9	Press SET key.	SET	The value is stored in memory and the current refrigerator temperature is displayed.

**Note:**

If no key has been pressed for about 90 seconds in the temperature set mode, the display mode returns automatically to the temperature display mode. In this case, the chamber temperature setting is not changed.

The effective temperature setting for refrigerator ranges between 2 and 14°C.

The stored items can be frozen partially when the set temperature of freezer is equal to or lower than 3°C.

The freezer temperature can be set in the range between -15 and -35°C. Remember that the guaranteed temperature with no load at an ambient temperature of 30°C is -30°C.

# OPERATING INSTRUCTIONS

## Key lock operation

This unit incorporates a key lock feature which can inhibit the tampering using the keys on the control panel.

The key lock is set to OFF at the factory.

Display	Mode	Function
L 0	Key lock OFF	Temperature change enabled
L 1	Key lock ON	Temperature change disabled

Table 2 Key lock setup procedure (Example: Key lock OFF ⇒ Key lock ON)

	Operation	Key operated	Indication after operation
			The current refrigerator or freezer temperature is displayed.
1	Press and hold the digit shift key for about 5 seconds.		The first digit of the temperature display blinks.
2	Set the first digit to 1 with the numerical value shift key.		Pressing the key shifts up the figure of the digit.
3	Press the set key.	SET	Key lock is set to ON and the current refrigerator or freezer temperature is displayed.

**Note:**

Key lock can be set any time when the current refrigerator or freezer temperature is displayed.

## Remote alarm terminal

The terminal of the remote alarm is installed at the left bottom of the unit. The alarm is outputted from this terminal.

Contact capacity is DC 30V, 2 A.

Contact output: At normal condition "Open"  
At abnormal condition "Close"

**Note:**

The alarm is actuated when the power cord is disconnected from the outlet and the power switch is OFF.

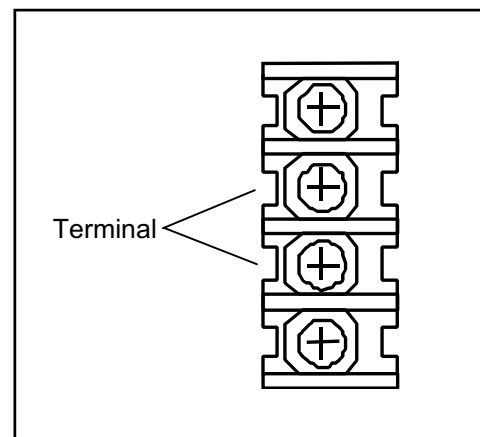

# OPERATING INSTRUCTIONS

## Alarm temperature setting

The high temperature and low temperature at which the alarm will be activated are effective for freezer and refrigerator. The following shows the outline of the alarm temperature setting.

Display	Mode	Application	Settable range
F01	High temp. alarm setting	Refrigerator	+2 to +14°C
F02	Low temp. alarm setting		-2 to -14°C
F03	High temp. alarm setting	Freezer	+5 to +15°C
F04	Low temp. alarm setting		-5 to -15°C

Table 3 shows the basic operation for high temperature alarm setting and table 4 shows low temperature alarm setting for refrigerator. Perform key operation in the sequence indicated in the table. The example in the table is based on the assumption that the high temperature alarm is activated when the chamber temperature deviates from set temperature by more than +3°C and low temperature alarm is activated when the chamber temperature deviates from set temperature by more than -3°C.

**Note:** The temperature alarm setting at the factory is as follows:

	High temp. alarm	Low temp. alarm
Refrigerator	Set temp. +5°C	Set temp. -5°C
Freezer	Set temp. +10°C	Set temp. -10°C

Table 3

	Operation	Key operated	Indication after operation
1		----	The current refrigerator temperature is displayed.
2	Press and hold the numerical value shift key for about 5 seconds.		The first digit of the temperature display blinks.
3	Set the first digit to 1 with the numerical value shift key. (Note 1)		The first digit of the temperature display blinks.
4	Press the set key.	SET	The current set value is displayed and the first digit of the temperature display flashes.
5	Set to 003 by using digit shift key and numerical value shift key.		Pressing the key leads the change of flashed digit.
			Pressing the key shifts up the figure of the current digit.
6	Press the set key.	SET	The value is stored in memory and the current refrigerator temperature is displayed.

**Note 1:** For the freezer, set the first digit to 3 (F03).

# OPERATING INSTRUCTIONS

Table 4

	Operation	Key operated	Indication after operation
1		----	The current refrigerator temperature is displayed.
2	Press and hold the numerical value shift key for about 5 seconds.		The first digit of the temperature display blinks.
3	Set the first digit to 2 with the numerical value shift key. (Note 1)		The first digit of the temperature display blinks.
4	Press the set key.	SET	The current set value is displayed and the first digit of the temperature display flashes.
5	Set to -03 by using digit shift key and numerical value shift key.		Pressing the key leads the change of flashed digit.
			Pressing the key shifts up the figure of the current digit.
6	Press the set key.	SET	The value is stored in memory and the current refrigerator temperature is displayed.

**Note 2:** For the freezer, set the first digit to 4 (F04).

# ALARMS AND SAFETY FUNCTIONS

This unit has the alarm and safety functions shown in Table 5, and also a self diagnostic function.

Table 5 Alarms and safety functions

Kind of alarm or safety	Situation	Indication	Buzzer	Safety operation
High temperature alarm	• Refrigerator If the chamber temperature exceeds the set temperature.	Alarm lamp flashes. All digits on the temperature display flash.	Intermittent tone after a delay of 15 minutes.	Remote alarm is activated after a delay of 15 minutes.
	• Freezer If the chamber temperature exceeds the set temperature.			
Over-heat protector	• Refrigerator If the chamber temperature exceeds 28°C.	----	----	Defrost heater and fan motor for circulation turn OFF.
Low temperature alarm	• Refrigerator If the chamber temperature is lower than the set temperature or drops to 0°C or lower.	Alarm lamp flashes. All digits on the temperature display flash.	Intermittent tone after a delay of 15 minutes. (No delay in the case of 0°C or lower)	Remote alarm is activated after a delay of 15 minutes. (No delay in the case of 0°C or lower)
	• Freezer If the chamber temperature is lower than the set temperature.			
Over-cool protector	• Freezer If the chamber temperature is equal or lower than 0°C.	----	----	Refrigerator comp. turns OFF. Reset at about 6°C.
Power failure alarm	In the event of a power failure or disconnection of power supply plug from the outlet	----	----	Remote alarm is activated.
Door alarm	When the door is open.	Door check lamp is lit.	Intermittent tone after a delay of 2 minutes.	----
Auto return	If a key operation is not performed for about 90 seconds in each setting mode.	Chamber temperature is displayed.	----	Setting mode is canceled.
Key lock	When the key lock is ON (L1).	----	----	Key input is unable.
Thermal sensor abnormality	If the thermal sensor of refrigerator goes open (E01) or short circuit (E02).	Alarm lamp flashes. E01/02 and chamber temp. are displayed alternately on the temperature display.	Intermittent tone	Remote alarm is activated. Operation by the defrost sensor.
	If the freezer sensor of refrigerator goes open (E03) or short circuit (E04).	Alarm lamp flashes. E03/04 and chamber temp. are displayed alternately on the temperature display.		Remote alarm is activated. Freezer will run continuously .
	If the defrost sensor goes Open (E05) or short circuit (E06).	Alarm lamp flashes. E05/06 and chamber temp. are displayed alternately on the temperature display.		Remote alarm is activated. Normal running.

**Note:**

The alarm can be canceled by pressing the alarm buzzer stop key (BUZZER), but the remote alarm cannot be silenced.

When more than two alarm conditions occur simultaneously, the smaller number error code has priority on the error display.

After a power failure, the unit will resume operation with the set value that was in place before power failure occurred.

# SETTING OF ALARM RESUME TIME

The alarm buzzer and remote alarm are silenced by pressing BUZZER key on the control panel during alarm condition. The buzzer and remote alarm will be activated again after certain suspension if the alarm condition is continued. The suspension time can be set by following the procedure shown in the Table 6 below.

The example in the table is based on the assumption that the desired duration is 20 minutes.

**Note:** The duration is set in 30 minutes at the factory.

Table 6 Procedure for setting of alarm resume time (Example; change from 30 minutes to 20 minutes)

	Operation	Key operated	Indication after operation
1		----	The current chamber temperature is displayed.
2	Press and hold the numerical value shift key for about 5 seconds.		The first digit of the temperature display blinks.
3	Set to F25 by using digit shift key and numerical value shift key.		Pressing the key leads the change of flashed digit.
			Pressing the key shifts up the figure of the current digit.
4	Press the set key.	SET	The current set value is displayed and the second digit of the temperature display flashes.
5	Set to 020 by using numerical value shift key.		Pressing the key shifts up the figure in the second digit.
6	Press the set key.	SET	The value is stored in memory and the current chamber temperature is displayed.

- The settable alarm resume times are 10, 20, 30, 40, 50, or 60 minutes (The set values are 010, 020, 030, 040, 050, and 060). The buzzer would not reset if the resume time is set in 000.
- The set mode returns to the temperature display mode automatically when 90 seconds has passed without any key operation. In this case, any setting before pressing SET key is not memorized.

# DEFROSTING

## Refrigerator

The following 2 kinds of defrost methods are adopted for the refrigerator, which control defrosting automatically.

### 1. Cycle defrost

To keep the temperature stable inside the chamber, the refrigeration compressor is cycled on and off. During “off” periods any frost which has accumulated on the evaporator is melted by energizing a heater. This will not have any discernible effect on the chamber temperature.

### 2. Forced defrost

When the ambient humidity is high, or a large amount of damp product is being stored inside the refrigerator, there is a possibility that cycle defrost may not be enough to remove all of the frost on the evaporator. In this case, a forced defrost cycle is initiated by the defrost sensor.

When the unit is operating under a forced defrost cycle, the current chamber temperature and “dF” is displayed alternately on the digital temperature display.

Once the forced defrost cycle is complete, normal operation resumes. The chamber air temperature rises up to about 10°C during the forced defrost cycle.

## Freezer

Natural defrost by stopping operation.

The defrosting is performed by stopping the freezer operation.

When the frost is built-up on the freezer wall, defrost the freezer by the following procedure as the freezer has no automatic defrosting function.

1. Temporarily move all the contents of the freezer to another freezer.

2. Set the freezer temperature to -00. “dF” is displayed on the digital temperature display. This is the starting of defrosting.

3. When the frost on the wall has been eliminated, remove the water and wipe the inside of the freezer completely.

4. Set the freezer temperature to desired one.

5. Once the chamber temperature has reached to the desired temperature, place the original contents back in the freezer.

**Note:** The freezer does not automatically reset to normal operation.

No temperature alarm is occurred during defrosting.

# MAINTENANCE

## **⚠ WARNING**

Always disconnect the power supply to the unit prior to any repair or maintenance of the unit in order to prevent electric shock or injury.

Ensure you do not inhale or consume medication or aerosols from around the unit at the time of maintenance. These may be harmful to your health.

## Cleaning

- Clean the unit once a month. Regular cleaning keeps the unit looking new.
- Use a dry cloth to wipe off small amounts of dirt on the outside and inside of the unit and all accessories. If the outside panels are dirty, clean them with a diluted neutral dishwashing detergent. (Undiluted detergent can damage the plastic components. For the dilution, refer to the instruction of the detergent.) After the cleaning with the diluted detergent, always wipe it off with a wet cloth. Then wipe off the cabinet or accessories with a dry cloth.
- Never pour water onto or into the unit. Doing so can damage the electrical insulation and may cause electric shock or short circuit.
- The compressor and other mechanical part are completely sealed. This unit requires absolutely no lubrication.

## Replacement of lamp

Follow the procedure below at the time of replacement of the lamp. The lamp is located at the upper front side of refrigerator chamber.

1. Disconnect the power supply plug.
2. To remove the lamp cover, hold the both sides of the cover with flexure and push it backward.
3. Remove the bulb from the socket by turning it to counterclockwise

**Caution:** Take care not to injure the fingers as the bulb can be hot!

< Bulb for replacement >

Incandescent lamp (T22E17) 125V, 10W (for AC 110/115V)  
(T22E17) 250V, 15W (for AC 220/230/240V)

4. Mount a new bulb and replace the lamp cover.

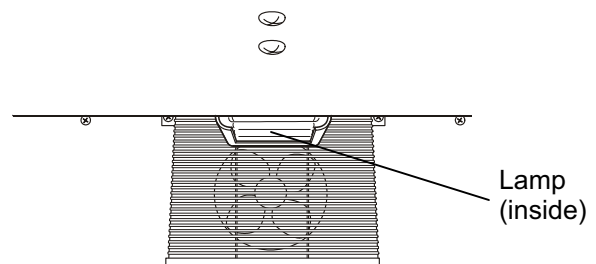

Fig. 1

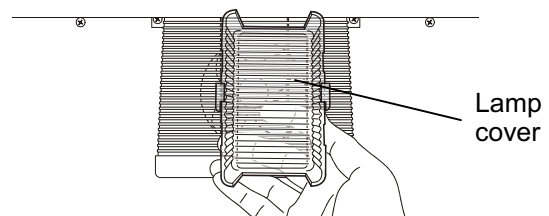

Fig. 2

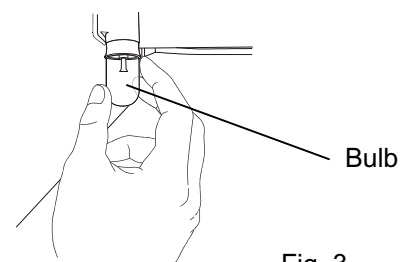

Fig. 3

# OPTIONAL COMPONENT

## Automatic temperature recorder

To record the chamber temperature, an optional automatic temperature recorder is available. Please consult with our sales department or agency for recorder installation.

For the proper usage of temperature recorder, refer to an instruction manual included with the recorder.

The available recorder and its attachment location are as follows:

Recorder type	Application	Attachment location (See figure below)
MTR-G3504	For both refrigerator and freezer	Lower right corner of the frame
MTR-0620LH	For refrigerator	Top right of the frame, or Lower right corner of the frame (in the case of monitoring of refrigerator only)
MTR-4014LH	For freezer	Lower right corner of the frame

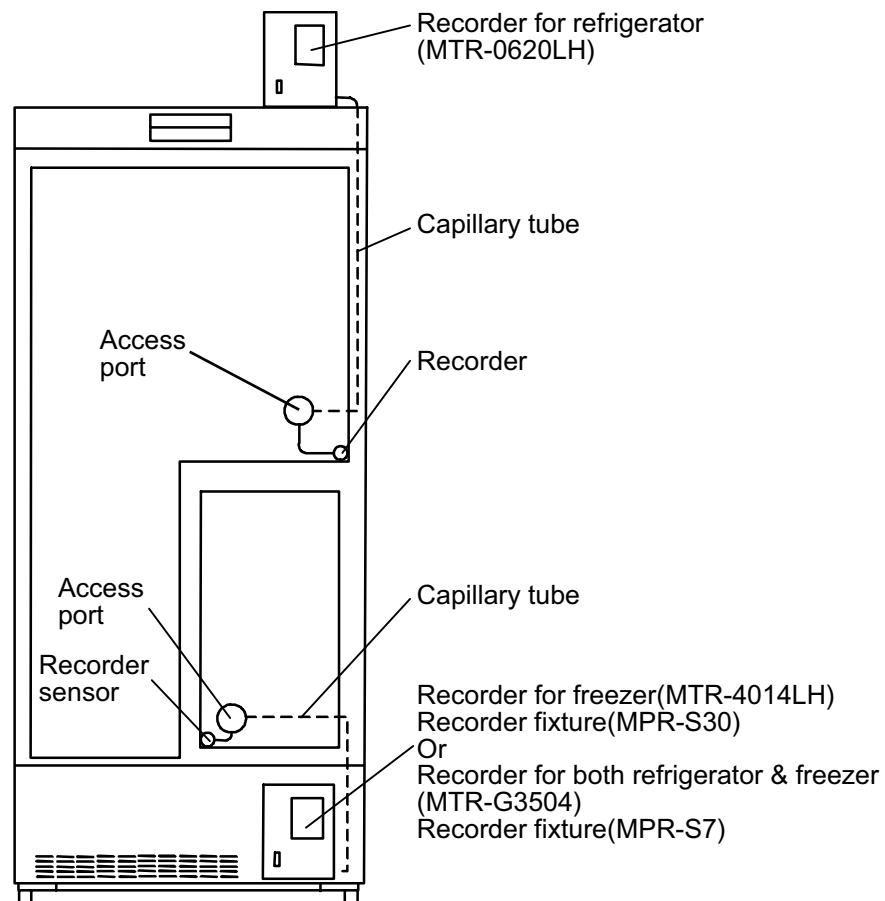

### ⚠️ WARNING

Always disconnect the power supply to the unit before starting the installation of recorder to prevent electric shock or injury.

# OPTIONAL COMPONENT

## Installation of recorder

### Refrigerator (MTR-0620LH)

1. Attach the fixture to the temperature recorder with two screws. (Fig. 1)
2. Remove the screws at the right corner on the top of the unit and fix the recorder to the attachment position. (Fig. 2)
3. Remove a rubber cap and insulation covering the access port on the back of the unit.
4. Take the recorder sensor into the refrigerator chamber through the access port.
5. Fix the recorder sensor on the right wall of the chamber with the enclosed clips. (Fig. 3)
6. Arrange the capillary tube so that it cannot disturb the shelves. Take care not to crush the tube when it is bent.
7. Make a cut on the rubber cap and pass the capillary tube through it. (Fig. 4)
8. Cover the access port with the insulation and rubber cap.

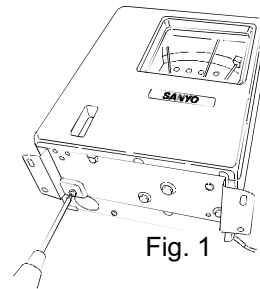

Fig. 1

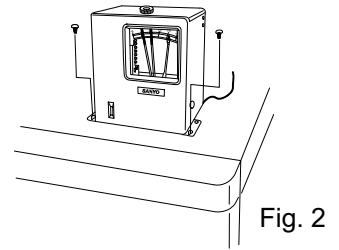

Fig. 2

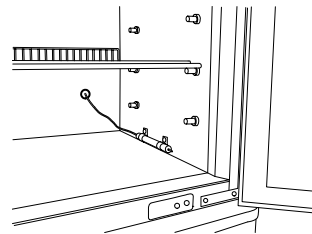

Fig. 3



Fig. 4

### Note:

The temperature recorder MTR-0620LH can be installed also at the mounting space of temperature recorder (bottom right of the cabinet) if the recorder for freezer (MTR-4014LH) is not installed. In this case, a dedicated recorder fixture (MPR-S30) is needed. For the installation, refer to “For freezer (MTR-4014LH)” below.

# OPTIONAL COMPONENT

## For freezer (MTR-4014LH)

1. Remove a cap for the fixing screw on the panel cover for mounting space of temperature recorder.
2. Remove the fixing screw and open the panel cover. (Fig. 5)
3. Remove the panel cover by pushing the shaft on both side outward.
4. Attach the temperature recorder (MTR-4014LH) to the recorder fixture (MPR-S30: optional component) by using the enclosed screws. (Fig. 6)
5. Mount the recorder fixture with recorder to the mounting space in the unit. (Fig. 7)
6. Route the recorder sensor and capillary tube as shown in the procedure 3 through 8 above and fix the sensor on the freezer wall (Fig. 8).

### Note:

The recorder MTR-4014LH cannot be installed at the right corner on the top of the cabinet even if the recorder for refrigerator (MTR-0620LH) is not installed there.

## For both refrigerator and freezer (MTR-G3504)

1. Remove a cap for the fixing screw on the panel cover for mounting space of temperature recorder.
2. Remove the fixing screw and open the panel cover. (Fig. 9)
3. Remove the panel cover by pushing the shaft on both side outward.
4. Attach the temperature recorder (MTR-G3504) to the recorder fixture (MPR-S7: optional component) by following the instruction shown in the procedure enclosed with the fixture.
5. Remove the connector cover. Then connect the power connector on the recorder to the connector on the unit side. (Fig. 10)
6. Mount the recorder fixture with recorder to the mounting space in the unit.
7. Fix the recorder sensor to each chamber by using clips, as mentioned in the procedure for MTR-0620LH and MTR-4014LH above.

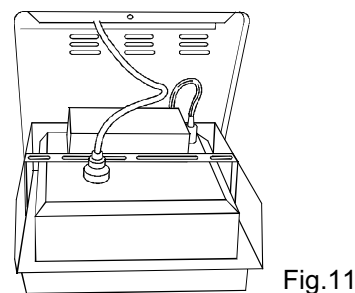
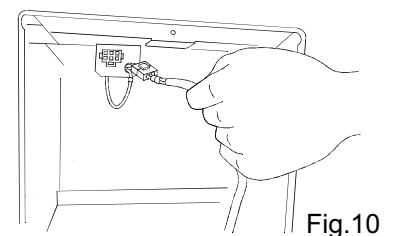
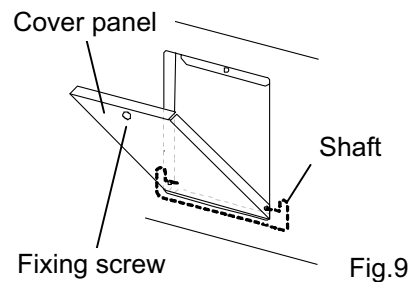
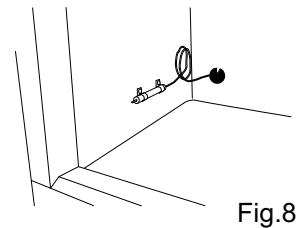
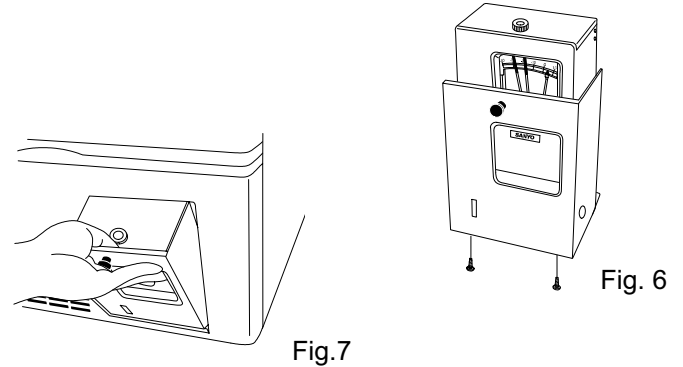
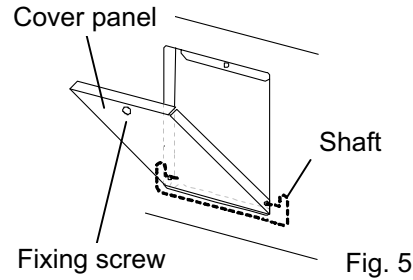

# TROUBLESHOOTING

If the unit malfunctions, check out the following before calling for service. In the case of no refrigeration or poor refrigeration, transfer the stored items to another refrigerator or freezer before checking out.

## **If nothing operates even when plug in**

1. The unit is not connected to the power supply or capacity of power source is not enough.
2. The power switch is not ON.
3. There is a power failure, the fuse is blown, or the circuit breaker is activated.

## **When the unit does not accept changes of set-point temperature**

1. The key lock is not "OFF".

## **When alarm is activated**

On start-up

1. The temperature in the unit does not match set value.

In use

1. The door was kept opened for long time.
2. The set value was changed.
3. The containers of high temperature (load) were put in the unit.

In these cases, alarm is removed automatically by running the unit for several hours.

## **When the unit does not get cold enough**

1. The air exhaust vent is blocked by refrigerator contents.
2. A large amount of warm product was put in the unit.
3. There is any heat sources in the unit.
4. The door is opened frequently.
5. The ambient temperature is too high.
6. The unit is in direct sunlight.
7. The door is not securely closed.
8. The door seal is damaged or foreign substance inserted between the door gaskets.

# DISPOSAL OF UNIT

## **WARNING**

If the unit is to be stored unused in an unsupervised area for an extended period **ensure that children do not have access and doors cannot be closed completely.**

**The disposal of the unit should be accomplished by appropriate personnel. Always remove doors to prevent accidents such as suffocation.**

# SPECIFICATIONS

Name	Pharmaceutical Refrigerator with Freezer	
Model	MPR-414F	MPR-414FS
External dimensions	W800 x D600 x H1805 (mm)	
Internal dimensions	W720 x D495x H1425 (mm) (Refrigerator) W317 x D440x H576 (mm) (Freezer)	
Effective capacity	340 L (Refrigerator), 82 L (Freezer)	
Exterior	Zinc galvanized steel, Polyester resin baked finish	
Interior	Stainless steel (Refrigerator), Painted aluminum plate (Freezer)	
Door	Acrylic finish baked on zinc galvanized steel Provided with glass window on the upper door (MPR-414F only)	
Insulation	Rigid polyurethane foamed-in place (CFC-FREE)	
Shelf	Polyethylene coated wire <Refrigerator> 2 large size; W700 x D366 (mm) Max. load; 25 kg/shelf 3 small size; W317 x D366 (mm) Max. load; 15 kg/shelf <Freezer> 1 shelf; W297 x D366 (mm) Max. load; 15 kg/shelf	
Access port	Inner diameter 30 mm, 2 ports on the back side (refrigerator, freezer)	
Cooling method	Forced air circulation (Refrigerator), Direct cooling (Freezer)	
Compressor	Hermetic reciprocating type, Output; 160 W x 2	
Evaporator	Fin and tube type (Refrigerator), Tube on sheet type (Freezer)	
Condenser	Wire and tube (Refrigerator), Rear side condenser (Freezer)	
Refrigerant	R-134a (Refrigerator), R-407D (Freezer)	
Defrosting	Cycle defrost and forced defrost (Refrigerator) Natural defrost by stopping operation (Freezer)	
Defrost heater	99 W (Refrigerator)	
Temperature controller	Microprocessor control system	
Temperature display	Digital display	
Thermal sensor	Thermister sensor (Refrigerator, Freezer)	
Alarm & Safety	High temp. alarm, Low temp. alarm, Power failure alarm, Door alarm Over-heat protector (Refrigerator), Over-cool protector (Refrigerator) Key lock, Thermal sensor abnormality, Circuit breaker (acts as power switch as well)	
Memory backup	Nonvolatile memory	
Lamp	Incandescent lamp (T22E17) x 1, 10W/15W (Refrigerator)	
Weight	126 kg	119 kg
Accessories	1 set of key, 2 large & 2 small nylon clips (for temperature recorder)	
Option	Automatic temperature recorder (MTR-G3504), Recorder fixture (MPR-S7) Automatic temperature recorder for freezer (MTR-4014LH), Recorder fixture (MPR-S30) Automatic temperature recorder for refrigerator (MTR-0620LH) Drawers for the bottom left compartment (MPR-41R)	

**Note :** Design or specifications will be subject to change without notice.

# PERFORMANCE

Control range	Refrigerator: 2°C to 14°C (Ambient temp.; -5°C to +35°C, No load) Freezer: -20°C to -30°C (Ambient temp.; -5°C to +30°C, No load)					
Noise level	39 dB (A scale)					
Maximum pressure	1.46 MPa (Refrigerator), 2.18 MPa (Freezer)					
Rated voltage	AC 110 V	AC 115 V	AC 220 V	AC 220 V	AC 230 V	AC 240 V
Rated frequency	60 Hz	60 Hz	50 Hz	60 Hz	50 Hz	50 Hz
Power consumption	375 W	390 W	350 W	370 W	350 W	365 W

**Note :** The unit with CE mark complies with EC directives 89/336/EEC, 93/68/EEC and 73/23/EEC.

## CAUTION

**Please fill in this form before servicing.  
Hand over this form to the service engineer to keep for his and your safety.**

### Safety check sheet

1. Refrigerator contents :
- |                                |                              |                             |
|--------------------------------|------------------------------|-----------------------------|
| Risk of infection:             | <input type="checkbox"/> Yes | <input type="checkbox"/> No |
| Risk of toxicity:              | <input type="checkbox"/> Yes | <input type="checkbox"/> No |
| Risk from radioactive sources: | <input type="checkbox"/> Yes | <input type="checkbox"/> No |

(List all potentially hazardous materials that have been stored in this unit.)

Notes :

2. Contamination of the unit

- |                  |                              |                             |
|------------------|------------------------------|-----------------------------|
| Unit interior    | <input type="checkbox"/> Yes | <input type="checkbox"/> No |
| No contamination | <input type="checkbox"/> Yes | <input type="checkbox"/> No |
| Decontaminated   | <input type="checkbox"/> Yes | <input type="checkbox"/> No |
| Contaminated     | <input type="checkbox"/> Yes | <input type="checkbox"/> No |
| Others:          |                              |                             |

3. Instructions for safe repair/maintenance of the unit

- |                                     |                              |                             |
|-------------------------------------|------------------------------|-----------------------------|
| a) The unit is safe to work on      | <input type="checkbox"/> Yes | <input type="checkbox"/> No |
| b) There is some danger (see below) | <input type="checkbox"/> Yes | <input type="checkbox"/> No |

Procedure to be adhered to in order to reduce safety risk indicated in b) below.

Date :

Signature :

Address, Division :

Telephone :

Product name: Pharmaceutical Refrigerator with Freezer	Model: MPR-414F/414FS	Serial number:	Date of installation:
--	--------------------------	----------------	-----------------------

Please decontaminate the unit yourself before calling the service engineer.



SANYO Electric Co., Ltd  
Printed in Japan