

Think GAIA
For Life and the Earth

SANYO

4 Megapixels Full HD Network
10x AF Zoom Camera

VCC-HD4000

1080p FULL
HD
NETWORK CAMERA

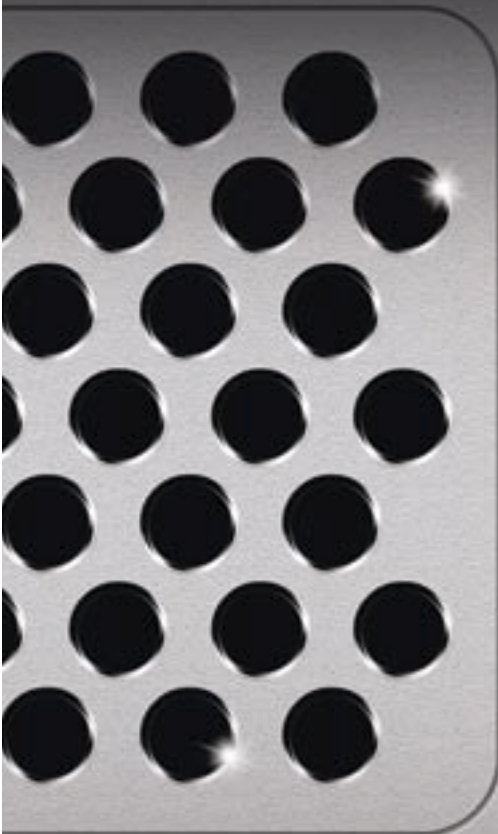

DAY NIGHT

FULL HD
1920 x 1080

1080p Full HD, 30 IPS with High-Quality Images

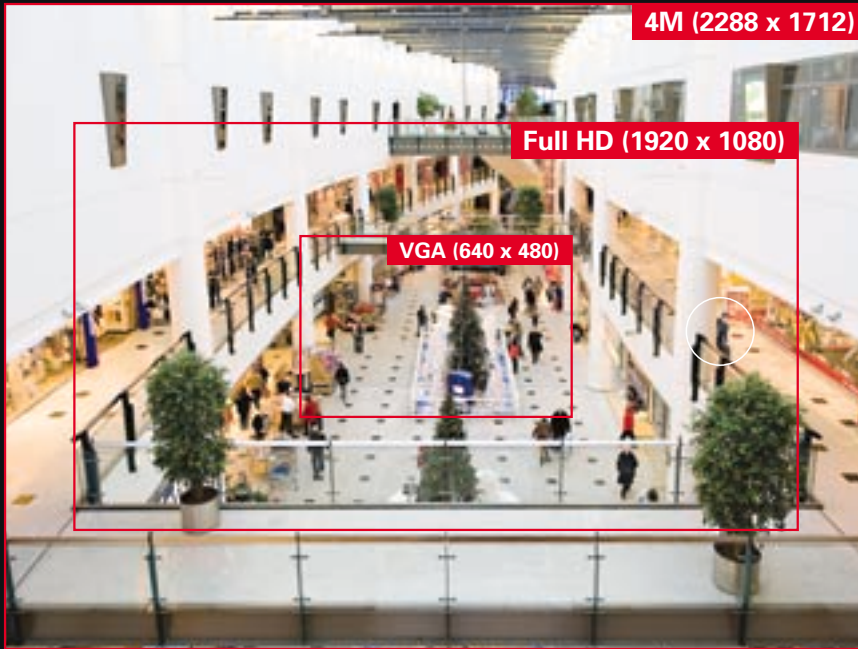

4 Megapixels resolution

Compared to conventional VGA cameras having a 640 x 480 pixel resolution, the 4 megapixels (2288 x 1712) CMOS newly employed in the SANYO VCC-HD4000 achieves a resolution approximately 9 times that of a conventional camera. This makes it possible to cover 9 times the monitoring area, the image quality being the same. In addition, image capture of detailed parts are clearer when these images are enlarged, provided shooting angles are the same.



Because of the higher quality of recorded images, areas that conventional cameras with a smaller pixel count cannot cover or confirm can be identified (if stored as local data).

Progressive scan CMOS sensor for image clarity

Most sensors utilize the interlace system which tends to make moving images jagged or blurred due to processing time differences. The VCC-HD4000 is equipped with a progressive scan system that ensures clear, smooth images are output.



Interlace image



Progressive image

No focus adjustment required for built-in 10x AF zoom lens

The VCC-HD4000 also incorporates a high-performance, high-resolution optical 10x AF lens that is Full HD compatible. Intensive focusing becomes unnecessary as the camera has been pre-optimized for best performance under actual use conditions, allowing highly detailed, sharp target capture. In addition, a separate digital 16x zoom-in function, along with the optical 10x zoom, can zoom up to 160x (max.).

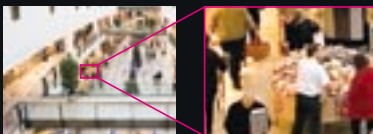

10x AF zoom lens

Dual Codec for Full HD with H.264 / 2288 x 1712 with JPEG

The VCC-HD4000 achieves 1080p (Full HD) 30 IPS with the H.264 high-performance compression codec optimized for network transmission. It also has a fine JPEG format resolution of 2288 x 1712 pixels. Monitoring can be conducted simultaneously in H.264 and JPEG formats by minimizing network traffic.

- H.264 ActiveX Plug-in required (bundled).

HD image recording on SD memory card or external 2.5" HDD

The VCC-HD4000 is equipped with an SD card slot for saving HD images to an SD memory card. If an external HDD is connected, important data can be stored over a longer period and in more quantity without having to use a PC. The camera is designed to ensure the integrity of stored data.

SD Memory Card
(sold separately)

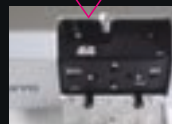

SD Card Slot



- SD memory cards and 2.5" hard disk drives are separately sold.
- HDD requires a dedicated case (separately sold).
- The HDD can also be installed above the main unit.

More clear, Easier to use



Human face detection

The VCC-HD4000 evaluates portions of human faces in order to automatically detect human faces. The AF function activates when human faces are detected. In addition, for images backlit by the sun, appropriate Backlight Compensation is performed. This unit is capable of detecting up to 32 human faces (max.).

Detects faces and applies optimum focus compensation



Before detection



After detection

Detects faces and applies optimum backlight compensation



Before detection



After detection

Clipping Function

When image data is output on a conventional SD output (composite) terminal, up to 4 VGA-sized sections (max.) of the displayed image can be selected, clipped and continuously monitored in sequence.

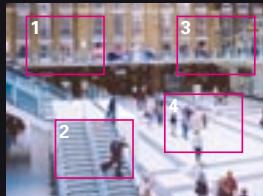

Clipping Function image

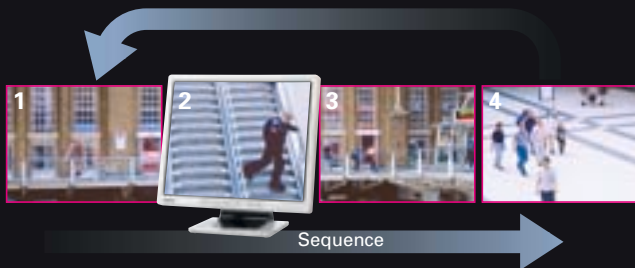

HD monitor

Equipped with an HDMI terminal

An HD monitor connects to the VCC-HD4000 with a single HDMI cable, allowing non-compressed digital images to be transferred without any loss of image quality.



HDMI HIGH-DEFINITION MULTIMEDIA INTERFACE

HDMI cable

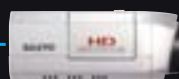

Privacy Masking

Addressing privacy issues, 5 masks (max.) are available for designated areas to prevent unauthorized display of anything that involves privacy on the display screen. Masking patterns are easily set with drag and drop.



Privacy Masking image

Smearless

The detection function offers two different advantages: Conventional CCD units are known to generate vertical noise (smears) associated with bright spots. The new sensor diminishes these smears and offers a clear and bright picture.

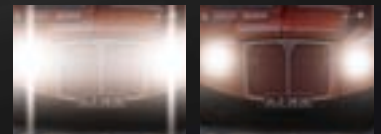

Conventional cameras VCC-HD4000

True Day/Night



A color camera, which captures objects in vivid colors in daylight, becomes a high-sensitivity B/W camera during the night and provides tiny details even in dark corners. A day/night camera is a two-in-one solution.

Alteration Detection

VCC-HD4000 verifies by itself whether or not an electronic alteration was made to original images.

Cable cover

System expandability has been designed into the versatile VCC-HD4000 which incorporates connections for HDTV, LAN, HDD, among others. The rear panel has a cable-cover for neat storage of external connection cables.



Recording time collation table based on the memory capacity and recording conditions

Codec	Resolution	Picture Quality	Recording Rate (max.)	Bit Rate (approx.)	Capacity for 1 hr. rec
H.264	1920 x 1080	SuperFine	30 ips	8.0Mbps	5.6GB
	1280 x 720	SuperFine	30 ips	6.6Mbps	4.7GB
	640 x 360	SuperFine	30 ips	1.8Mbps	1.5GB
	1920 x 1080	Basic	30 ips	4.0Mbps	2.9GB
	1280 x 720	Basic	30 ips	2.5Mbps	2.0GB
	640 x 360	Basic	30 ips	0.55Mbps	0.64GB
JPEG	2288 x 1712	SuperFine	3 ips	13.0Mbps	6.0GB
	1920 x 1080	SuperFine	5 ips	12.4Mbps	5.7GB
	640 x 360	SuperFine	30 ips	13.4Mbps	6.2GB
	2288 x 1712	Basic	3 ips	4.8Mbps	2.4GB
	1920 x 1080	Basic	5 ips	5.4Mbps	2.7GB
	640 x 360	Basic	30 ips	4.8Mbps	2.4GB

*Bit rate and 1 hr. rec data are approximate.

Advanced Network Solution



Transmission using 2 types of codecs (H.264 and JPEG) is possible.

For video compression, H.264, optimized for transmission of moving images over a network with low bit transfer rates, is used to enable real-time high image quality monitoring, and for still images JPEG is used to offer high image quality in a common image format. Monitoring can be performed according to the user's application, so that any important scene is not missed.

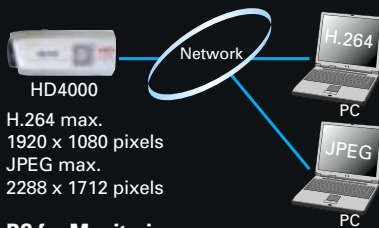

PC for Monitoring

By simply using Internet Explorer (ver. 6.0 or higher) on a personal computer, the user has access to full color video images from the camera. Saving JPEG images on a PC is also possible by using VA-SW3050S server software.

Not impacted by network problems

Automatically restarts network image data transmission after a network problems is resolved.

Alarm Buffering Function

This function saves the video images recorded during an alarm recording internally or to an SD memory card before streaming them. This prevents the loss of the image data even if image transmission delay occurs due to bandwidth limitations or network traffic conditions.

HDC Downloader (bundled)

Video data recorded on an SD memory card or HDD can be downloaded to a PC.

- Select JPEG or H.264
- Search for video data to be downloaded by data and time
- Connect SD or HDD to PC directly to copy video data



DL Viewer (bundled)

This is used to play back downloaded video or recorded data on SD or HDD.

- JPEG or H.264 can be played back.
- Images can be saved and printed.

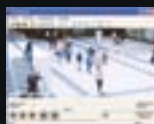

Other Features

- Power-over-Ethernet (PoE)
- Multi-cast
- Backup for interruption of network recording
- Internal log files: up to 100 access Logs & up to 200 system information
- E-mail function
- SSL-compatible (JPEG only)

Network recording software

VA-SW3050S (for server)/VA-SW3050C (for client)

The VCC-HD4000 is bundled with VA-SW3050LITE viewer software allowing live video streams sent from cameras to be monitored on a PC.

The network recording software VA-SW3050S / VA-SW3050C (sold separately) is an application program that extends the network operation of the camera. By installing this software, it is possible to monitor images from multiple cameras on a split screen and access and operate up to 128 cameras over a network. VA-SW3050S further offers the convenience of recording live images and alarm/timer functions. It is an exclusive software package for the VCC-HD4000.

Live images from a single camera can be viewed on a PC using Internet Explorer* (ver. 6.0 or higher). To view live images from multiple cameras, install the included VA-SW3050LITE viewer software.

* ActiveX installation is required.



Main window (Internet Explorer)

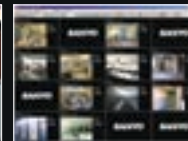

16-screen display (VA-SW3050LITE / VA-SW3050C)

SANYO Video Pilot* (VP) / Video Management Software (VMS)

VA-VP200* / SW50 (Advanced)

VA-VP300* / SW60 (Enterprise)

"SANYO Video Pilot* / Video Management Software" is a software management platform for SANYO's VCC-HD4000 and IP cameras, most of the industry's standard IP and megapixel cameras and encoders, several of the major video capture card codecs, and SANYO's embedded DVRs. Video Pilot / Video Management Software is an NVR, PC DVR and embedded DVR control platform with total integration all under one software application.

*Only for North America

• Please visit "sanjosecurity.com" for further details.



VP capture screen image



VMS capture screen image

Feature Comparison

	Internet Explorer*1	VA-SW3050 Series			VP / VMS	
		Lite	Server	Client	Advanced	Enterprise
		VA-SW3050Lite Bundled	VA-SW3050S Sold Separately	VA-SW3050C Sold Separately	VA-VP200*/SW50 Sold Separately	VA-VP300*/SW60 Sold Separately
No. of cameras supported	1	Max. 128			16	unlimited
Live Monitor	✓	✓	—	✓	✓	
Camera Control	✓	✓	—	✓	✓	
Video Recording	—	—	✓ (JPEG only)	✓	✓	
Playback	—	—	—	✓	✓	
Video Search	—	—	—	✓	✓	
Download from PC/Print	— / —	— / ✓	— / —	✓ / ✓	✓ / —	
Camera Setting	✓	—	—	—	—	
MegaPixel Camera	✓	✓	✓	✓	✓	
DVR Connection	—	—	—	—	✓	

*Only for North America

System Requirements

PC	IBM PC/AT and compatibles		
OS	Windows® XP Professional SP2, Windows® Vista, Windows® Server 2003 SP2 (SW3050S only)		
CPU	Core2Duo E6700, 2.66GHz or higher*2	Core2Duo E6700, 2.66GHz or higher*2 Core2Duo E8500, 3.16GHz or higher*3	Pentium IV, 3.0GHz or higher Core2Duo E6700, 2.66GHz or higher*2 Core2Duo E8500, 3.16GHz or higher*3
Memory	1GB (Windows® XP) 2GB (Windows® Vista)*2	1GB (Windows® XP) 2GB (Windows® Vista)*2 2GB or more	1GB or more 1GB (Windows® XP) 2GB (Windows® Vista)*2 2GB or more
Network Interface	100Base-TX		
Display Card	1920 x 1200 pixels or higher	1024 x 768 pixels or higher, 16m color	
Graphic chip	HD (HDMI)	ATI: Radeon HD2600 series or higher nVidia: GeForce 8600 series or higher Quadro FX550 series or higher	
	SD (Compo)	ATI: Radeon X1000 series or higher nVidia: GeForce 6000 series or higher Quadro4 series or higher	
Audio	— Sound card with 100% Direct-X compatibility and speakers*4		

*1 Ver. 6.0 or higher

*2 When the number of cameras connected is 4 or fewer

*3 When the number of cameras connected is between 5 and 16

*4 The camera main unit is not equipped with audio functions.

* For Full-HD display

SANYO Software Development Kits (SDK)

SANYO now offers two types of SDKs to help the user develop applications suitable for particular needs or for more compatibility with network devices and software from different vendors.

*For further information of the SDK, please contact the nearest SANYO representative.

Note:

Depending on your computer's performance or network environment, the system may enter the busy state if the PC is connected to many H.264 video channels. If a warning message appears in the dialog box, decrease the number of the connected H.264 video channels.

Six reasons for recommending the VCC-HD4000

- (1) Since the number of pixels is approximately 9 times that of a conventional camera (VGA), it will cover 9 times the monitoring area, the image quality being the same.
- (2) Zooming the display during playback offers higher quality with clearer print output.
- (3) Costs less. The number of cameras used can be fewer because a high pixel count camera can cover a more expanded area. In addition, costs for camera main unit, cables, housing and installation can also be reduced.
- (4) Also compatible with PoE, which does not require power-supply installations. Simply inserting a LAN/ethernet connector allows extension.
- (5) Built-in zoom lens incorporates AF so that additional lens purchases are not required while installation and set-up are simple.
- (6) Also equipped with an optical zoom lens.

Application: BANKS

Applications/Advantages:

- Monitoring and assured recording of fraudulent acts on premises
- 24/7 operations for crime prevention systems coordinated by monitoring centers
- Contributes to improved service and enhanced levels of customer confidence
- Applicable to staff training and customer service improvement
- Flexible expandability to cope with future change and expansion



Local recording/alarm terminal synchronization

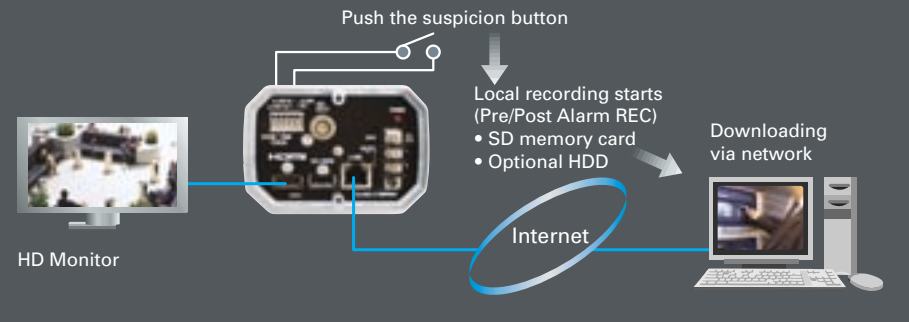

Application: SMALL STORES

Applications/Advantages:

- Low-cost setup of a high-performance, easy-to-operate surveillance system
- Readiness against trouble and incident, deterrent to illicit behavior
- Reduced inventory loss due to product damage and theft
- Verification of customer traffic flows for effective product displays
- Improvement of in-store staff conduct and attitude

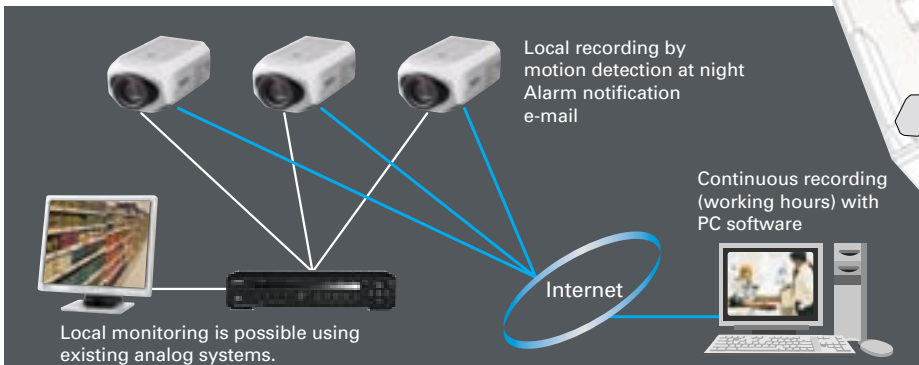
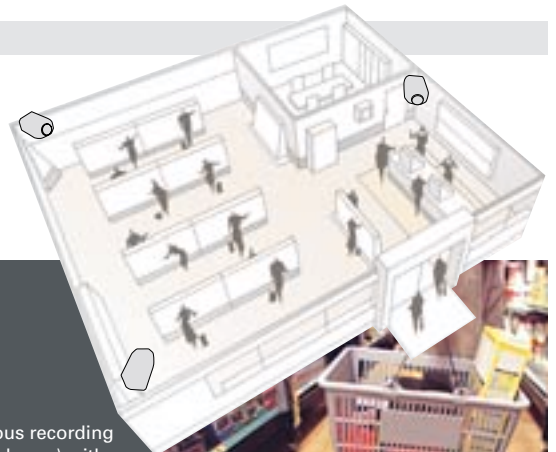

Examples of System Introduced



Bank



Parking

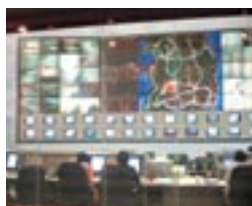

Traffic control center



Casino



Factory

Specifications

Model No.	VCC-HD4000	
Lens		
Image sensor	1/2.5" CMOS sensor	
Effective picture elements	2320 (H) x 1728 (V) approx. 4 Megapixels	
Recording picture elements	2288 (H) x 1712 (V) approx. 3.92 Megapixels	
Lens	Focal length: f=6.3 – 63.0mm (Optical 10x) F number: F1.8 – 2.5 Digital zoom: 16x	
CAMERA		
Image size	H.264	16:9 HD 1920 x 1080p 30ips HD 1280 x 720p 30ips, 960 x 540P 30ips, 640 x 360p 30ips, 320 x 180p 30ips 4:3 1080 x 720p, 720 x 480p 30ips, 360 x 240p 30ips
	JPEG	16:9 HD 1920 x 1080, HD 1280 x 720, 1024 x 576, 640 x 360 4:3 4M 2288 x 1712, 2M 1600 x 1200, 1280 x 960, 1024 x 768, 800 x 600, 640 x 480, 320 x 240
Synchronizing system	Internal synchronization	
Minimum illumination	2 lx (F1.8, color, gain: High) 0.1 lx (F1.8, b/w, gain: High)	
Video S/N ratio	50dB (AGC OFF)	
Day/Night	Auto/Color/Black and White	
Auto focus	AUTO/MANUAL/ONE-PUSH; Selectable focus area	
White balance	ATW/AWC/MWB/Outdoor/Indoor/Fluorescent Adjustable R and B signals in MWB mode	
Backlight compensation	Multi-spot metering/Center-zone metering/Face/OFF, Mask settings possible	
Electronic shutter	1/30, 1/60, 1/100, 1/250, 1/500, 1/1000, 1/2000, 1/4000, 1/10000 LONG shutter: x1, x2, x4, x8, x16, x32	
Iris control	AUTO/MANUAL, Selectable electronic shutter in manual mode	
AGC	Normal/Middle/High/Off, Adjustable gain control in Off mode	
Gamma	0.45/1, other settings available	
Aperture compensation	ON/OFF	
Electronic sensitive boost	AUTO/OFF, Max. 32x	
Privacy masking	ON/OFF, Max. 5 masks	
Motion detector	ON/OFF, Selectable area detection, Selectable sensitivity level, Human face detection, Motion alarm zoom function; Selectable magnified ratio and duration time *Available in preset positions	
Menu language	English/Spanish/German/French/Japanese	
Camera title	16 characters	
Recording and Playback		
Image quality	Selectable	
Recording rate	Selectable	
Recording mode	Alarm recording (Pre/Post setting, Selectable recording rate) Suspicion recording (Selectable recording rate), Timer recording	
Input/Output		
SD card slot	1 (SDHC supported)	
USB port	Supported HDD	
Video output	HD output HDMI port SD output composite (BNC terminal, NTSC)	
Network	RJ-45 port (10BASE-T/100BASE-TX)	
Alarm input	2 (NO/NC setting. This output is also used for day/night control of color, B/W and auto mode)	
Alarm output	1 (Selectable NO/NC; open collector)	
External lens control	Zoom/Focus/Common (Voltage control: $\pm 6 \sim \pm 12V$)	
Operation button	SET button and Cursor buttons (These are used for MENU and Zoom/Focus)	
Network		
Image compression	H.264/JPEG	
Picture quality	Selectable	
Bandwidth	No limitation and selectable bandwidth limitation	
Interface	10BASE-T/100BASE-TX, PoE (IEEE802.3af) compatible	
Protocols	TCP/IP, UDP, HTTP, HTTPS, SMTP, NTP, DHCP, FTP, UPnP, DDNS	
Simultaneous access	Max. 16	
Security	BASIC authentication (ID/password) SSL supported (JPEG only)	
Others		
Environmental conditions	-10°C to 50°C / Less than 90% RH	
Power supply	24V AC $\pm 10\%$, 60 Hz or 12V to 15V DC	
Power consumption	12.3 W	
Dimensions	95 (W) x 67 (H) x 159 (D) mm	
Weight	710g (25.0 oz.)	

Dimensions

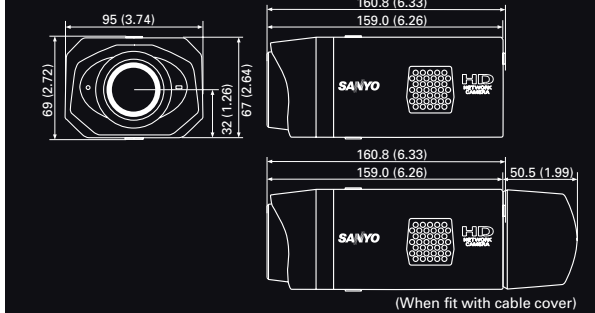

Rear panel

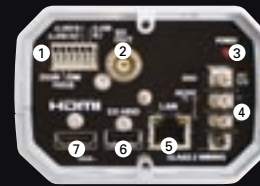

Side panel

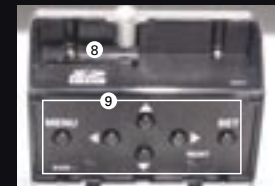

- 1 Control terminals
- 2 SD Output (Composite)
- 3 Power indicator
- 4 Power connection terminals (24V AC, 12V DC, GND)
- 5 LAN I/F (RJ45)
- 6 USB I/F (EX-HDD only)
- 7 HD Output (HDMI)
- 8 SD card slot
- 9 Operation buttons

Optional Accessories (sold separately)

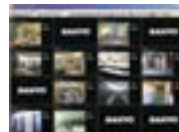

Network Recorder
VA-SW3050S
for server PC
VA-SW3050C
for client PCs



Video Pilot* (VP)
VA-VP200*
(Advanced)
VA-VP300*
(Enterprise)



Video Management Software (VMS)
VA-SW50 (Advanced)
VA-SW60 (Enterprise)



Wide Conversion Lens
VCP-L07W



Hard Disk Case
VA-HDC4000

SD Memory Card

2.5" HDD (Hard Disk Drive)

- * Only for North America
- Please visit "sanyosecurity.com" for further details.
- Please use the HDD by a combination with VA-HDC4000.
- VA-HDC4000 has protection of special circuit for the data.

HDMI, the HDMI Logo and High-Definition Multimedia Interface are trademarks or registered trademarks of HDMI Licensing LLC. Microsoft and Windows are either registered trademarks or trademarks of Microsoft Corporation in the United States and/or other countries. Intel and Pentium are trademarks or registered trademarks of Intel Corporation or its subsidiaries in the U.S. and other countries. All other trademarks are the property of their respective owners.

Notes:

- Frame rates are variable dependent upon network line conditions and PC performance.
- Because products and software described in this brochure are subject to continuous improvement; SANYO reserves the right to modify product specifications, functions and design without notice.
- Screen images are simulated.
- Comparative images are representations only.
- If a 2.5" HDD is used, a dedicated case (sold separately) is required.

Caution: Please consult the instruction manual to ensure safe and proper operation of the product.



Digital System Company of SANYO Electric Co., Ltd. obtained Quality Management System ISO 9001 and Environmental Management System ISO 14001 certifications.

Distributed by:

SANYO

SANYO Electric Co., Ltd.
Digital System Company
<http://www.sanyosecurity.com>

©2008 SANYO Printed in Japan 2008.11 MA
SMS170